



Mono-Clip

**Mono-Clip – neues 2-teiliges System mit
einzigartiger Clip-Technik und glatter Oberfläche**

**Mono-Clip – new two-part system with
unique clip technology and smooth surface**



⇅ 7 – 22 mm



Neues 2-teiliges Clip-System

New 2-part clip system

Mono-Clip – in drei BASIS-Profil Größen

Mono-Clip – in three BASE profile sizes

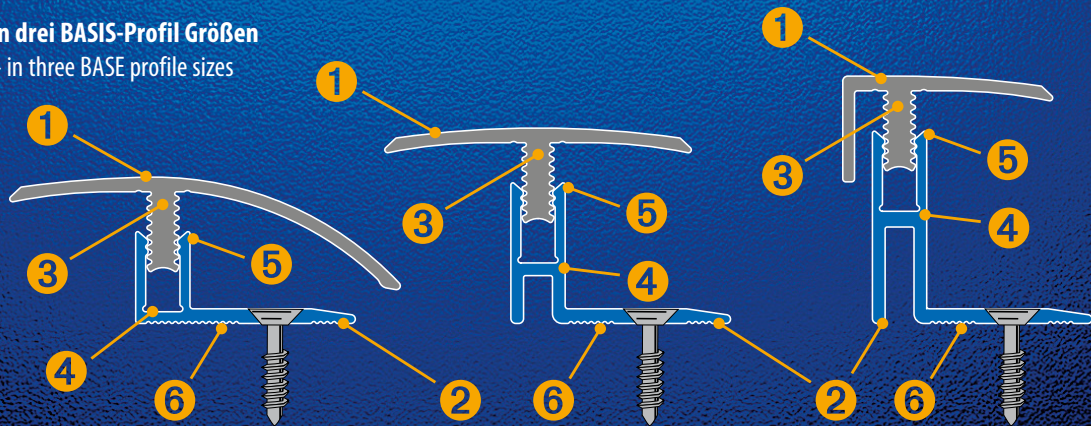

Technische Änderungen vorbehalten.
Subject to technical changes.

© Küberit®

Mono-Clip

- ❶ TOP-Profil
- ❷ BASIS-Profil (**drei Größen**)
Befestigung mit TORX-Schraube
(Verdübelung neben der Estrichfuge)
- ❸ Führungssteg mit Sicherheitsrastung
- ❹ Sollbiegestelle
- ❺ Kontersteg mit 2-Punkt-Verzahnung
- ❻ Kleberrillen (Verklebung bei Fußbodenheizung)

Mono-Clip

- ❶ TOP profile
- ❷ BASE profile (**three sizes**)
fastening with TORX screws
(anchor alongside the subfloor joint)
- ❸ positive-engagement guide strip
- ❹ predetermined bending point
- ❺ counter edge with 2-point-interlock system
- ❻ fluted for glueing (glue in case of underfloor heating)

Mono-Clip – das neue 2-teilige Aluminium Profilsystem verfügt über einen schmalen Gesamtaufbau und ist geeignet für Laminat, Parkett, Starkparkett sowie mehrschichtig modulare Fußbodenbeläge. Lieferbar in drei Versionen mit Anwendungsbereichen von 7 – 12 mm, 12 – 17 mm und 17 – 22 mm.

- Clip-System mit neuer, einzigartiger Clip-Technologie für die schwimmende Verlegung
- ermöglicht 13 mm Dehnungsfugen – über 60% mehr Nutzen als herkömmliche Profilsysteme
- unser Übergangprofil verfügt bei optimierter Dehnungsfuge über lediglich 31,5 mm sichtbare Fläche
- schnelle und einfache Profilverlegung
- die kraftschlüssige Clip-Verbindung ermöglicht die Aufnahme von horizontalen und vertikalen Kräften
- für alle Höhen das gleiche TOP-Profil

Mono-Clip - the new 2-part aluminium profile system has a slim overall structure and is suitable for laminate, parquet, thick parquet and multi-layer modular floor coverings. Available in three versions with application ranges of 7 - 12 mm, 12 - 17 mm and 17 - 22 mm.

- Clip system with new, unique clip technology for floating installation
- achieved through 13 mm expansion joints – covering a 60% larger application area than conventional profile systems
- connecting profile has only 31.5 mm visible surface area despite optimised expansion joint
- quick and easy profile installation
- the secure clip connection enables flooring to withstand horizontal and vertical forces
- TOP profile suitable for all heights

Mono-Clip | Laminat

Mono-Clip | Laminate

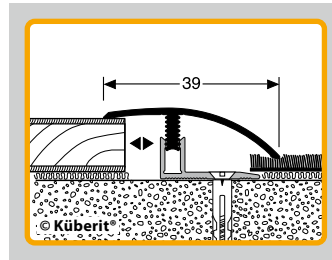
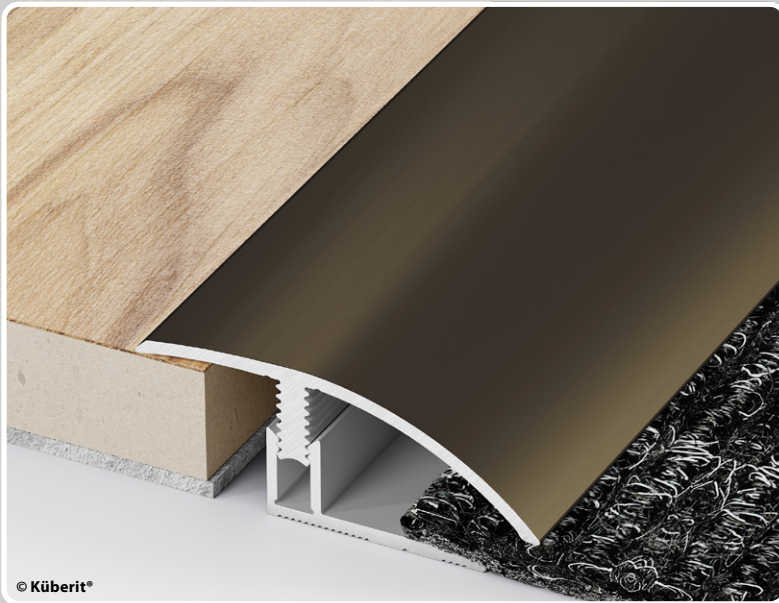

13 mm

556*

⇅ 7 – 12 mm

ANPASSUNGSPROFIL

(oder AUSGLEICHSPROFIL) für alle Bodenbeläge an angrenzende, niedrigere Flächen oder Beläge

ADAPTING PROFILE

(or LEVELLING PROFILE / REDUCER PROFILE) for all floor coverings bordering lower areas or floors

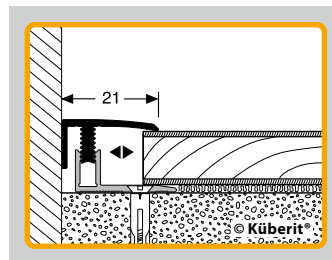

13 mm

557*

⇅ 7 – 12 mm

ABSCHLUSSPROFIL

für saubere Abschlüsse und Begrenzungen von Bodenbelägen vor höheren, angrenzenden Schwellen, Kacheln, Fliesen, Terrassentüren und -fenstern oder anderen Erhöhungen

BORDER PROFILE

for neat borders of floor coverings in front of higher sills, tiles, terrace doors and windows or other raisings

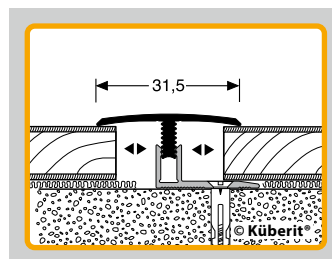
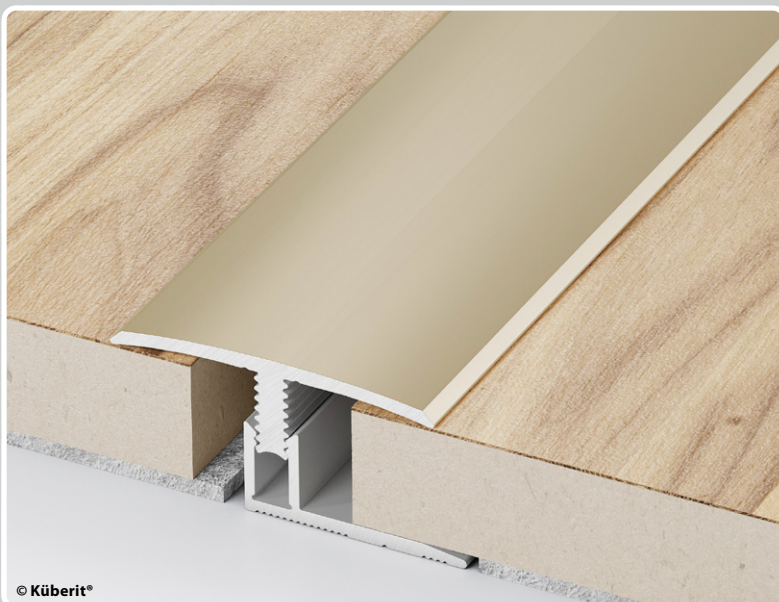

2 x 13 mm

558*

⇅ 7 – 12 mm

ÜBERGANGSPROFIL

(oder DEHNUNGSFUGENPROFIL) für gleich hohe oder bis zu ± 2 mm unterschiedlich hohe Bodenbeläge

CONNECTING PROFILE

(or EXPANSION JOINT PROFILE) for floor coverings of equal level or up to ± 2 mm difference in height

*auch mit Holzdekor erhältlich

*also available with wood decor

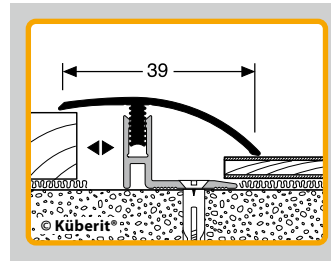
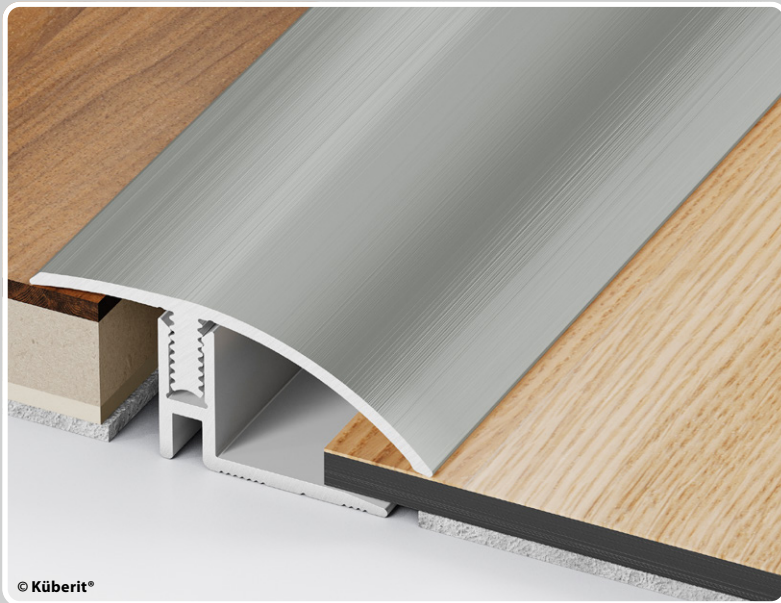

559*
 ⚡ 12–17 mm

ANPASSUNGSPROFIL

(oder AUSGLEICHSPROFIL) für alle Bodenbeläge an angrenzende, niedrigere Flächen oder Beläge

ADAPTING PROFILE

(or LEVELLING PROFILE / REDUCER PROFILE) for all floor coverings bordering lower areas or floors

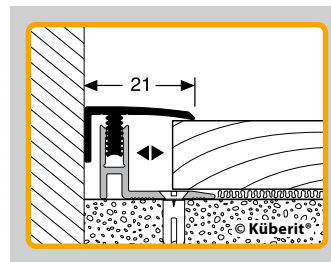

560*
 ⚡ 12–17 mm

ABSCHLUSSPROFIL

für saubere Abschlüsse und Begrenzungen von Bodenbelägen vor höheren, angrenzenden Schwellen, Kacheln, Fliesen, Terrassentüren und -fenstern oder anderen Erhöhungen

BORDER PROFILE

for neat borders of floor coverings in front of higher sills, tiles, terrace doors and windows or other raisings

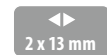
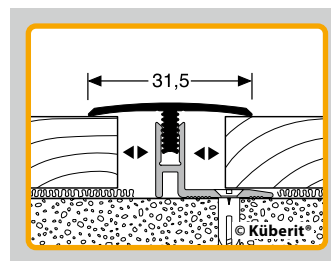

561*
 ⚡ 12–17 mm

ÜBERGANGSPROFIL

(oder DEHNUNGSFUGENPROFIL) für gleich hohe oder bis zu ± 2 mm unterschiedlich hohe Bodenbeläge

CONNECTING PROFILE

(or EXPANSION JOINT PROFILE) for floor coverings of equal level or up to ± 2 mm difference in height

***auch mit Holzdekor erhältlich**

***also available with wood decor**

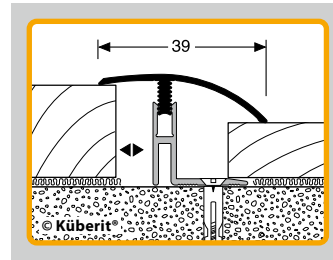

13 mm

562
⇅ 17–22 mm

ANPASSUNGSPROFIL

(oder AUSGLEICHSPROFIL) für alle Bodenbeläge an angrenzende, niedrigere Flächen oder Beläge

ADAPTING PROFILE

(or LEVELLING PROFILE / REDUCER PROFILE) for all floor coverings bordering lower areas or floors

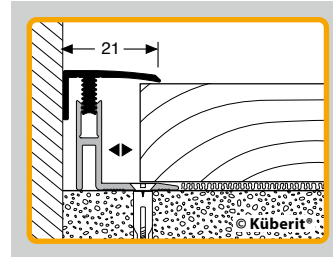

13 mm

563
⇅ 17–22 mm

ABSCHLUSSPROFIL

für saubere Abschlüsse und Begrenzungen von Bodenbelägen vor höheren, angrenzenden Schwellen, Kacheln, Fliesen, Terrassentüren und -fenstern oder anderen Erhöhungen

BORDER PROFILE

for neat borders of floor coverings in front of higher sills, tiles, terrace doors and windows or other raisings

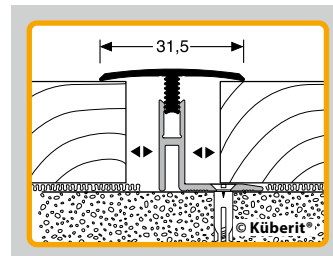

2 x 13 mm

564
⇅ 17–22 mm

ÜBERGANGSPROFIL

(oder DEHNUNGSFUGENPROFIL) für gleich hohe oder bis zu ± 2 mm unterschiedlich hohe Bodenbeläge

CONNECTING PROFILE

(or EXPANSION JOINT PROFILE) for floor coverings of equal level or up to ± 2 mm difference in height

Clip-Technik

clip technology

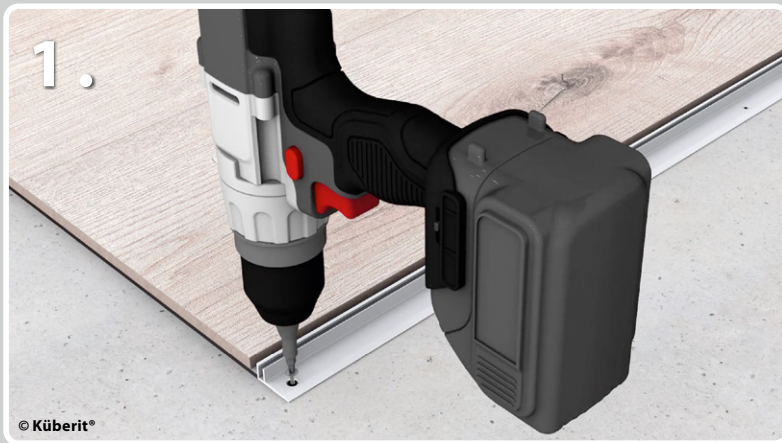

BASIS-Profil verschrauben oder verdübeln (= Durchsteckmontage) bzw. bei Fußbodenheizung einen 2-Komponenten-Kleber verwenden.

Fasten the **BASE profile** with screws and plugs (= plug mounting). In case of floor heating, fix the profile by using a suitable cartridge adhesive.

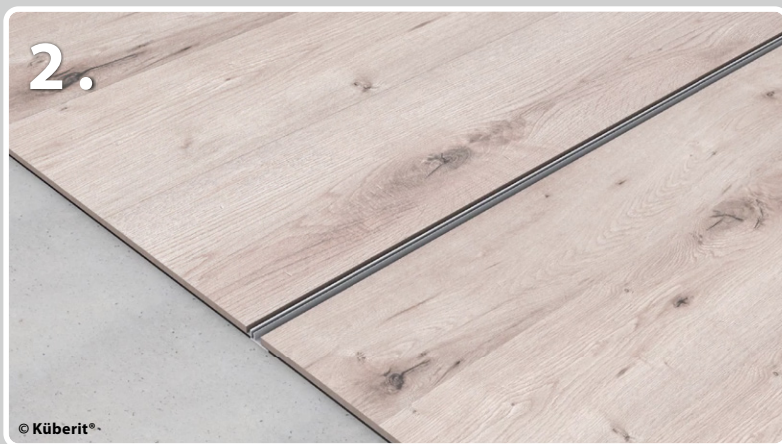

Hartbodenbelag anpassen, dabei die vom Hersteller empfohlene **Dehnungsfuge** berücksichtigen!

Lay the hard floor covering and pay attention to the **expansion joint** as recommended by the flooring manufacturer!

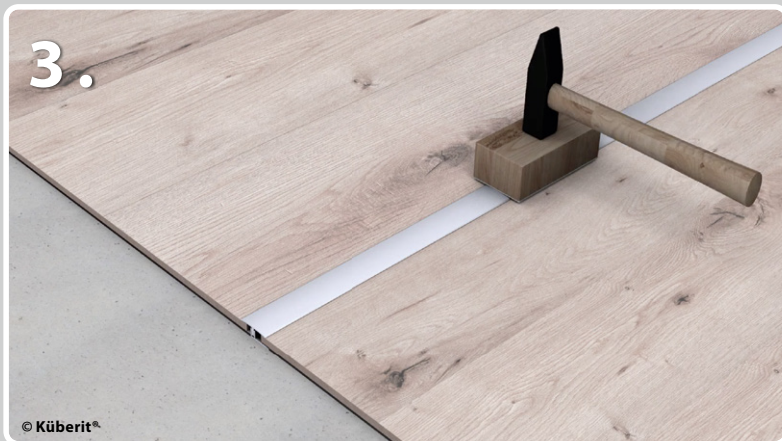

TOP-Profil vorsichtig auf das **BASIS-Profil** aufsetzen, eventuell noch in die richtige Position korrigieren, dann das **TOP-Profil** mit wohl dosierten Schlägen passgenau einclippen.

ACHTUNG: Nicht mit dem Hammer direkt klopfen, sondern immer ein Hartholz mit Filz benutzen.

Fertig ist die hochwertige Verlegung!

Place the **TOP profile** carefully on the **BASE profile**, bring it first into the right position, then clip-in the **TOP profile** by well controlled hammer blows.

ATTENTION: Never use the hammer directly. Please use a hardwood with felt.

The high-quality installation is ready!

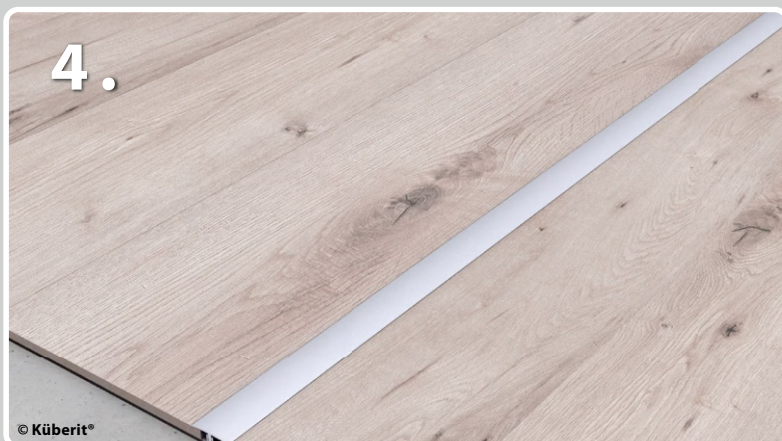

VIDEO



kueberit.com/qr/mono

Mono-Clip

Mono-Clip



1,0 m / 2,0 m / 2,7 m / 3,0 m

© Küberit®

Mono-Clip – Muster und Verkaufshilfen

Mono-Clip – sample case and sales assistants



Mustertafel Mono-Clip
sample board Mono-Clip

Technische Änderungen sowie Abweichungen in Maserung, Farbe, Irrtümer und Druckfehler vorbehalten!
Subject to technical changes and deviations in grain and colour. Subject to errata, printing errors!



Handmuster
sample swatches



Handmuster
sample swatches



Handmuster
sample swatches

SYMBOLE · SYMBOLS

Ha für Hartböden
for hard floor coverings

zum clippen
to clip

FARBEN · COLOURS

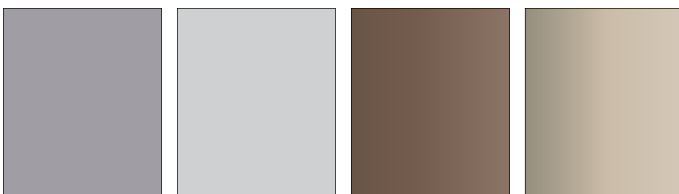

F2G
edelstahloptik f.g.
stainless steel m.b.

F4
silber
silver

F6
bronze
bronze

F9
sand
sand

HOLZDEKOR · WOOD DECOR



H30
Eiche hell
oak light

H33
Eiche weiß gekalkt
white washed oak



ORIGINAL **Küberit**®
since 1863

Küberit Profile Systems GmbH & Co. KG
Römerweg 9 • 58513 Lüdenscheid • Germany

Tel.: +49 2351 9507 0

Fax: +49 2351 9507 49

Fax Export: +49 2351 9507 200

www.kueberit.com

kueberit@kueberit.com • export@kueberit.com

Ihr Küberit-Fachhändler · Your Küberit dealer

PDF



kueberit.com/qr/prosp

©Küberit® 04/2020