



- **speziell für die Bad- und Wandsanierung**
especially for bathroom and wall renovation
- **schnelle Renovierung**
quick renovation
- **geringer Aufwand und wenig Schmutz**
little effort and little dirt

Design-Wandprofile

Bad- und Wandrenovierung leicht gemacht:
Design-Wandprofile für Aluminium-
Verbundsysteme, Vinyl- oder HPL-Platten

Bathroom and wall renovation made easy:
designer wall profiles for aluminum
composite systems, vinyl or HPL panels





NACHHER · AFTER

VIDEO



kueberit.com/qr/dwand

© Küberit®

Badsanierung mit Küberit Design-Wandprofile

Für die Badrenovierung z.B. mit HPL-Schichtstoffplatten oder für Aluminium-Verbundsysteme haben wir ein Design-Wandprofilsortiment entwickelt, das die Montage der Platten und die Arbeiten an den Stößen und Kanten wesentlich erleichtert. Das Ergebnis sind fugenlose, pflegeleichte Oberflächen, die die Hygiene verbessern sowie die Schmutz- und Schimmelbildung verhindern. Die bewährte Profiltechnik von Küberit wird vom Boden auf die Wand fortgeführt.

Bathroom renovation with Küberit designer wall profiles

For bathroom renovation, e.g. with HPL laminate panels or for aluminum composite systems, we have developed a designer wall profile range that makes it much easier to install the panels and work on the joints and edges. The result is jointless, easy-to-clean surfaces that improve hygiene and prevent the formation of dirt and mold. Küberit's proven profile technology is continued from the floor to the wall.

Neue Design-Wandprofile aus Aluminium

New designer wall profiles made of aluminium

FÜR 3 BIS ZU 5 MM BELÄGE · FOR 3 - 5 MM COVERINGS

ABSCHLUSSPROFIL
BORDER PROFILE

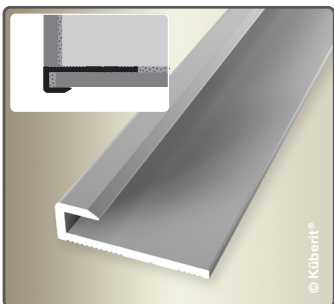
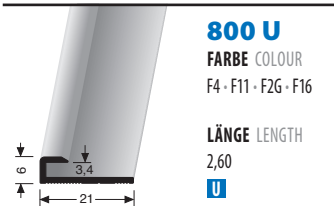

ABSCHLUSSPROFIL
BORDER PROFILE

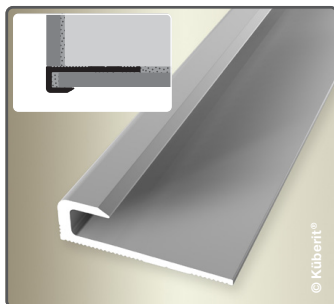
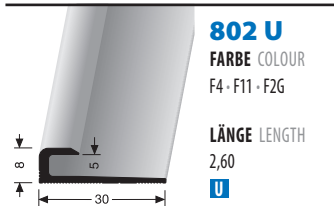

EINFASSPROFIL
EDGE TRIM

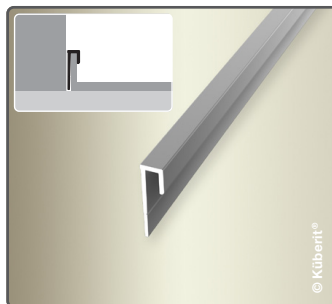
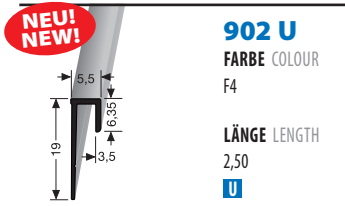

EINFASSPROFIL
EDGE TRIM

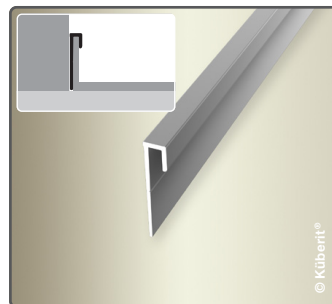
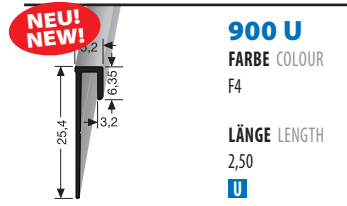

PLATTENSTOSS-SCHIENE
PANEL JOINT RAIL

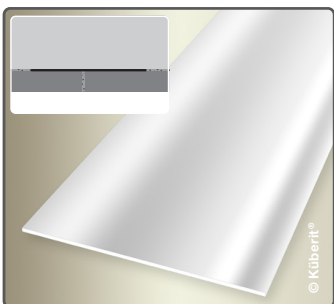
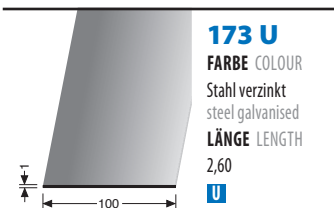

SOCKELLEISTE
SKIRTING

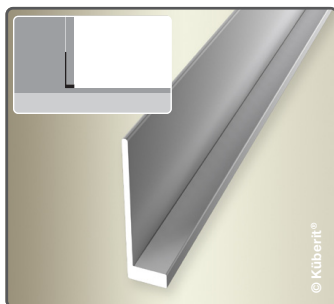
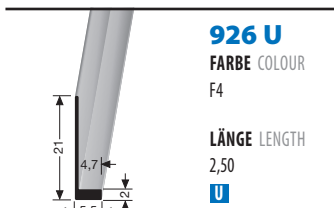

2-TEILIGER CLIP-VERBINDER
2-PART CLIP CONNECTOR

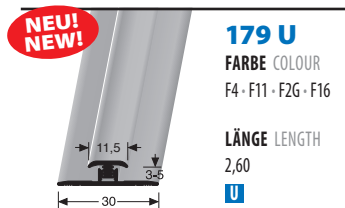

2-TEILIGER CLIP-VERBINDER
2-PART CLIP CONNECTOR

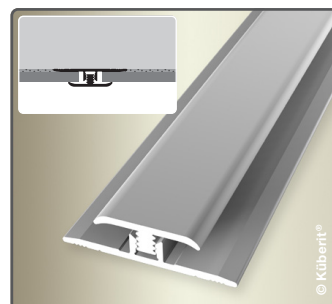
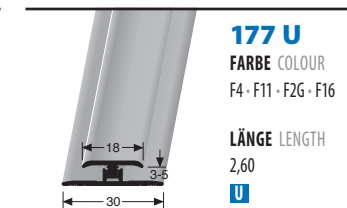

2-TEILIGE CLIP-AUSSENECKE
2-PART CLIP EXTERIOR CORNER

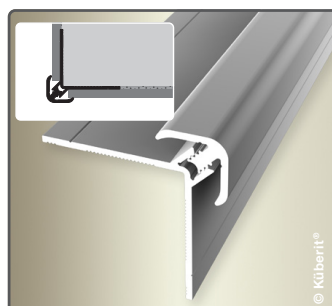
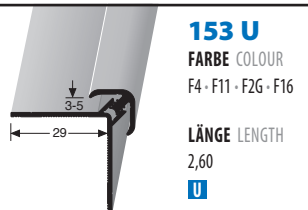

2-TEILIGE CLIP-INNENECKE
2-PART CLIP INTERIOR CORNER

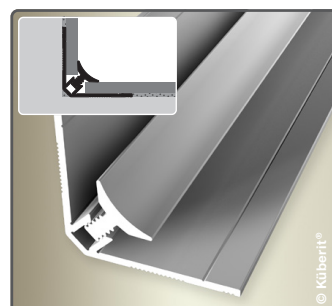
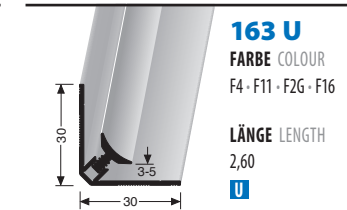



VORHER · BEFORE

© Kübert®



NACHHER · AFTER

© Kübert®

Moderne Wandgestaltung mit unseren Design-Wandprofilen

Modern wall renovation with our designer wall profiles

FÜR BIS ZU 8,2 mm BELÄGE · FOR UP TO 8,2 mm COVERINGS

H-VERBINDER
H CONNECTOR

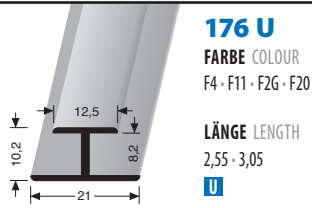

176 U
FARBE COLOUR
F4 · F11 · F2G · F20
LÄNGE LENGTH
2,55 · 3,05
U

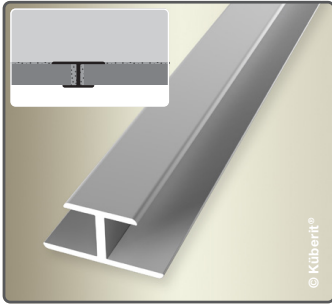

KOMBI INNEN- UND AUSSENECKE
INTERIOR/EXTERIOR CORNER

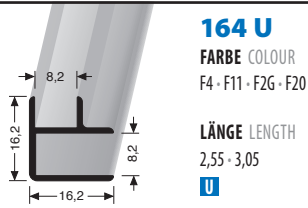

164 U
FARBE COLOUR
F4 · F11 · F2G · F20
LÄNGE LENGTH
2,55 · 3,05
U

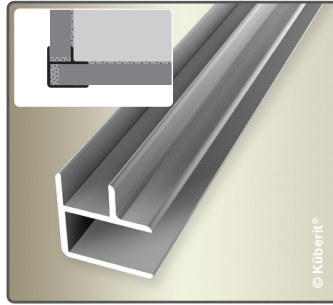

U-ABSCHLUSSPROFIL
U BORDER PROFILE

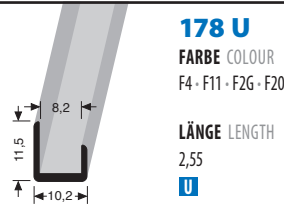

178 U
FARBE COLOUR
F4 · F11 · F2G · F20
LÄNGE LENGTH
2,55
U

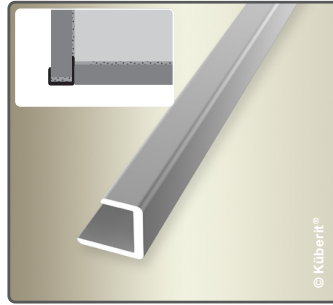

L-ABSCHLUSSPROFIL
L BORDER PROFILE

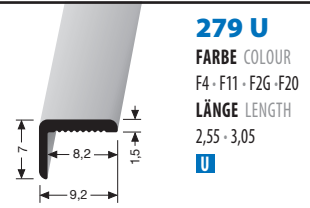

279 U
FARBE COLOUR
F4 · F11 · F2G · F20
LÄNGE LENGTH
2,55 · 3,05
U

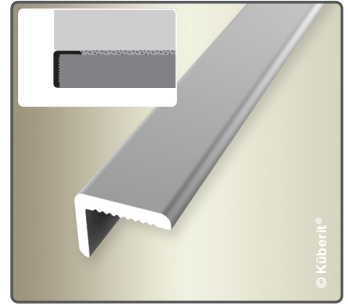

FÜR 4,5 BIS ZU 7 MM, 7,5 | 8,0 mm BELÄGE · FOR 4,5 – 7 MM, 7,5 | 8,0 mm COVERINGS

2-TEILIGE CLIP-INNENECKE
2-PART CLIP INTERIOR CORNER

**NEU!
NEW!**

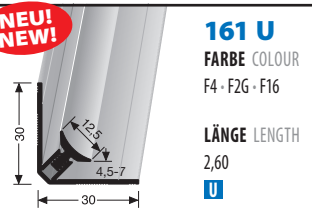

161 U
FARBE COLOUR
F4 · F2G · F16
LÄNGE LENGTH
2,60
U

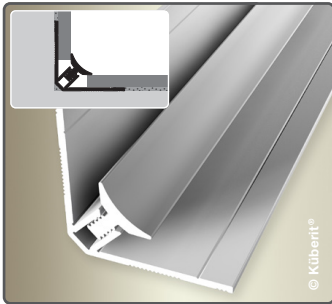

KOMBI INNEN- UND AUSSENECKE
INTERIOR/EXTERIOR CORNER

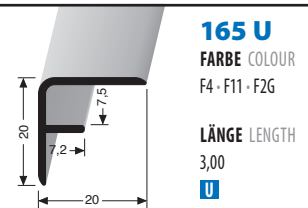

165 U
FARBE COLOUR
F4 · F11 · F2G
LÄNGE LENGTH
3,00
U

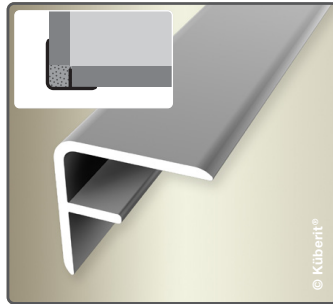

ABSCHLUSSPROFIL
BORDER PROFILE

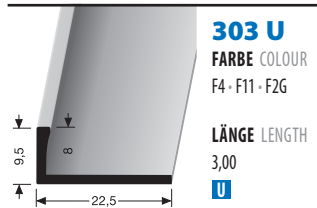

303 U
FARBE COLOUR
F4 · F11 · F2G
LÄNGE LENGTH
3,00
U

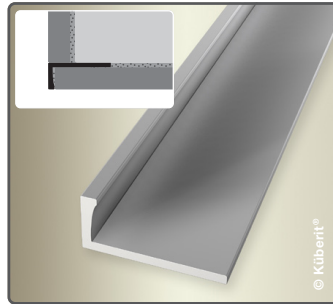

ZUBEHÖR · ACCESSORIES



Formteile für die Wandprofile 151 U und 161 U finden Sie auf unserer Produktplattform!

Moulded parts for the wall profiles 151 U and 161 U can be found on our product platform!

**NEU!
NEW!**

151 AE
AUSSENECKE
EXTERNAL CORNER

OBEN TOP
UNTEN BOTTOM

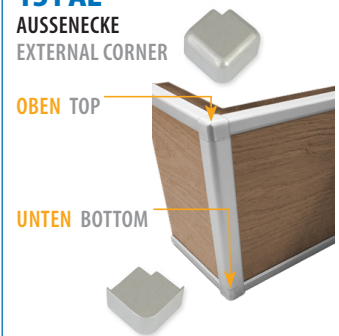

2-TEILIGE CLIP-AUSSENECKE
2-PART CLIP EXTERIOR CORNER

**NEU!
NEW!**

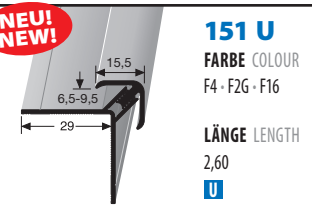

151 U
FARBE COLOUR
F4 · F2G · F16
LÄNGE LENGTH
2,60
U

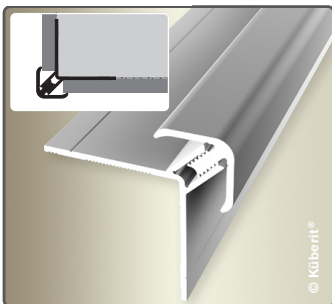

2-TEILIGER CLIP-VERBINDER
2-PART CLIP CONNECTOR

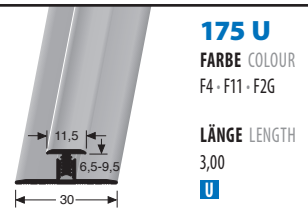

175 U
FARBE COLOUR
F4 · F11 · F2G
LÄNGE LENGTH
3,00
U

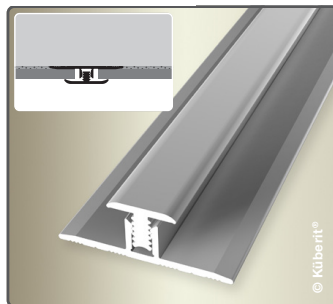

2-TEILIGE CLIP-INNENECKE
2-PART CLIP INTERIOR CORNER

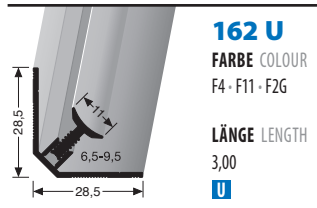

162 U
FARBE COLOUR
F4 · F11 · F2G
LÄNGE LENGTH
3,00
U

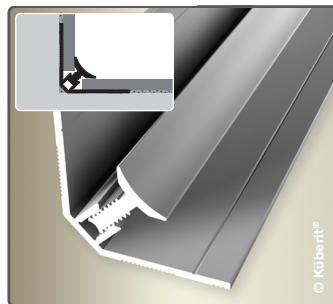

161 IE
INNENECKE
INTERNAL CORNER

OBEN TOP
UNTEN BOTTOM

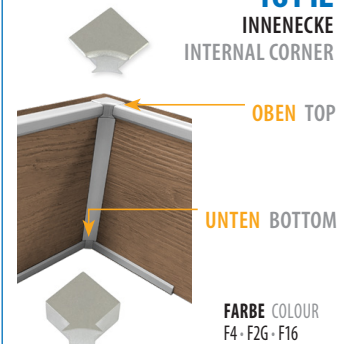

FARBE COLOUR
F4 · F2G · F16

Die Formteile für 151 und 161 sind nur in Verbindung mit einer Belagsstärke von 7 mm und dem Abschlussprofil 803 – oben und unten – einsetzbar!

The moulded parts for 151 and 161 can only be used in conjunction with a covering thickness of 7 mm and the 803 end profile – top and bottom!

Entdecken Sie auch unsere Wand- und Tapetenprofile ...

Discover our wall and wallpaper profiles ...

FÜR 2 mm BELÄGE · FOR 2 mm COVERINGS

AUSSENECKE
EXTERIOR CORNER

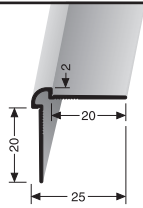

150
FARBE COLOUR
F4 · F5 · F2G
F15 · F16
LÄNGE LENGTH
2,70
U G

AUSSENECKE
EXTERIOR CORNER

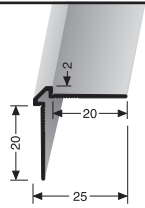

155
FARBE COLOUR
F4 · F5 · F2G
F15 · F16
LÄNGE LENGTH
2,70
U G

INNENECKE
INTERIOR CORNER

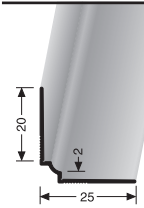

160
FARBE COLOUR
F4 · F5 · F2G
F15 · F16
LÄNGE LENGTH
2,70
U G

VERBINDER
CONNECTOR

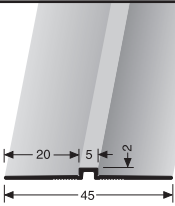

170
FARBE COLOUR
F4 · F5 · F2G
F15 · F16
LÄNGE LENGTH
2,70
U G

ABSCHLUSSPROFIL
BORDER PROFILE

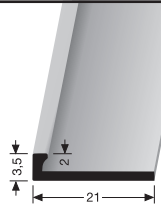

299
FARBE COLOUR
F4 · F5 · F2
F15 · F16
LÄNGE LENGTH
2,50
U G

ABSCHLUSSPROFIL
BORDER PROFILE

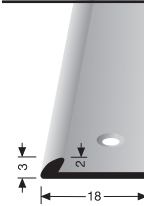

355
FARBE COLOUR
F4 · F5 · F2
F15 · F16
LÄNGE LENGTH
2,50



VIDEO



kueberit.com/qr/wand

... und unsere Eckschutzwinkel

... and our corner guards

AUSSENWINKEL
EXTERIOR ANGLE

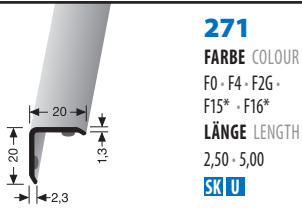

271
FARBE COLOUR
F0 · F4 · F2G ·
F15* · F16*
LÄNGE LENGTH
2,50 · 5,00
SK U

AUSSENWINKEL
EXTERIOR ANGLE

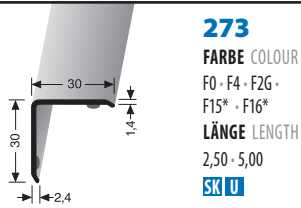

273
FARBE COLOUR
F0 · F4 · F2G ·
F15* · F16*
LÄNGE LENGTH
2,50 · 5,00
SK U

AUSSENWINKEL
EXTERIOR ANGLE

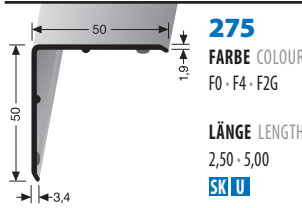

275
FARBE COLOUR
F0 · F4 · F2G
LÄNGE LENGTH
2,50 · 5,00
SK U

ZUBEHÖR · ACCESSORIES



Endkappen für die Eckschutzwinkel finden Sie auf unserer Produktplattform! End caps for the corner guards can be found on our product platform!

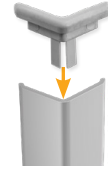

NEU! NEW!

AUSSENWINKEL, 3-fach gekantet
EXTERIOR ANGLE, 3-side edged

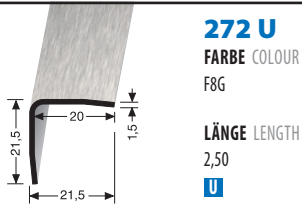

272 U
FARBE COLOUR
F8G
LÄNGE LENGTH
2,50
U

AUSSENWINKEL, 3-fach gekantet
EXTERIOR ANGLE, 3-side edged

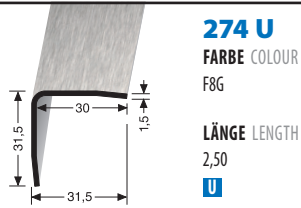

274 U
FARBE COLOUR
F8G
LÄNGE LENGTH
2,50
U

AUSSENWINKEL, 3-fach gekantet
EXTERIOR ANGLE, 3-side edged

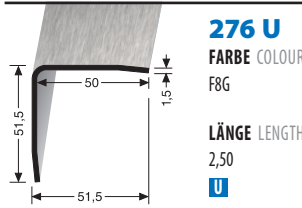

276 U
FARBE COLOUR
F8G
LÄNGE LENGTH
2,50
U

AUSSENWINKEL, 3-fach gekantet
EXTERIOR ANGLE, 3-side edged

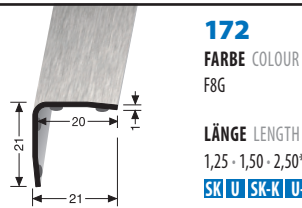

172
FARBE COLOUR
F8G
LÄNGE LENGTH
1,25 · 1,50 · 2,50**
SK U | SK-K | U-K

AUSSENWINKEL, 3-fach gekantet
EXTERIOR ANGLE, 3-side edged

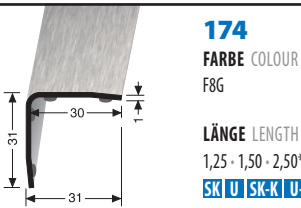

174
FARBE COLOUR
F8G
LÄNGE LENGTH
1,25 · 1,50 · 2,50**
SK U | SK-K | U-K

AUSSENWINKEL
EXTERIOR ANGLE

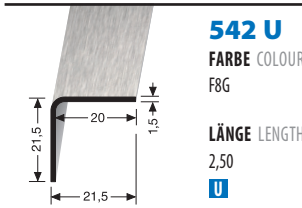

542 U
FARBE COLOUR
F8G
LÄNGE LENGTH
2,50
U

AUSSENWINKEL
EXTERIOR ANGLE

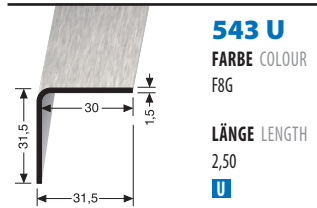

543 U
FARBE COLOUR
F8G
LÄNGE LENGTH
2,50
U

AUSSENWINKEL
EXTERIOR ANGLE

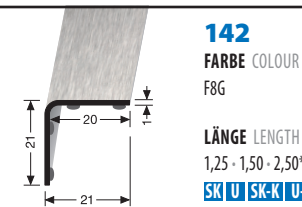

142
FARBE COLOUR
F8G
LÄNGE LENGTH
1,25 · 1,50 · 2,50**
SK U | SK-K | U-K

AUSSENWINKEL
EXTERIOR ANGLE

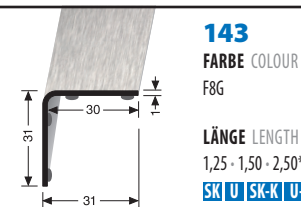

143
FARBE COLOUR
F8G
LÄNGE LENGTH
1,25 · 1,50 · 2,50**
SK U | SK-K | U-K

* F15 / F16 nur in 2,50 m erhältlich! - F15 / F16 only available in 2.50 m!
** Krone auf Anfrage lieferbar! - Crown available on request!

Selbstklebende Ausführung dient nur als Montagehilfe!
Adhesive serves only as an assembling aid!



FARBEN · COLOURS

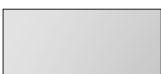

F0
Alu natur
Alu natural



F2G
Alu eloxiert edelstahloptik
fein geschliffen
Alu anodized stainless steel
optic brushed



F2
Alu eloxiert edelstahloptik
Alu anodized stainless steel
optic



F4
Alu eloxiert silber
Alu anodized silver



F5
Alu eloxiert gold
Alu anodized gold



F11
Alu eloxiert silber glanz
Alu anodized bright silver



F8G
Edelstahl matt gebürstet
Stainless steel matte brushed



F15 RAL9016
Alu pulverbeschichtet weiß
Alu powder-coated white



F16 RAL9005
Alu pulverbeschichtet
schwarz matt
Alu powder-coated
black matte



F20 RAL9004
Alu pulverbeschichtet
schwarz matt supreme
Alu powder-coated
black matte supreme

NEU! NEW!

U = ungebohrt - undrilled

SK = selbstklebend - self-adhesive

G = geschlossene Doppel-K Stanzung - closed perforated anchor

K = 45°-Krone - 45°-Crown

Irrtümer, Druckfehler, Technische Änderungen sowie Abweichungen in der Farbe vorbehalten!
Subject to errata, printing errors, technical changes and deviations in colour!

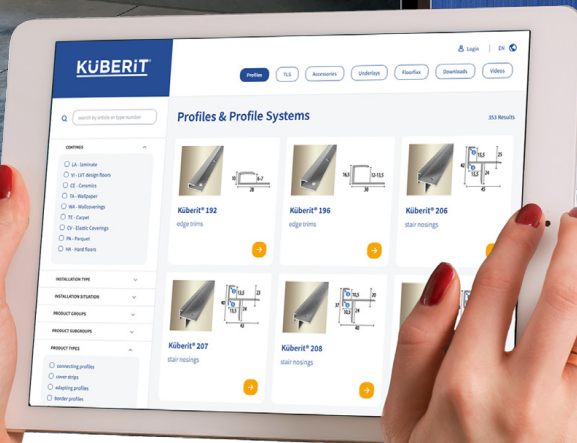

PRODUCT PLATFORM
pro.kueberit.com

- komplett neue Suche mit umfangreichen Filtermöglichkeiten
- getrennte Bereiche für Profile, Zubehör und Unterlagsbahnen
- optimierte Detailsicht mit 3D-Bildern der Profile in der jeweiligen Farbe

- completely new search with extensive filter options
- separate areas for profiles, accessories and underlays
- optimised detail view with 3D images of the profiles in the respective colour

KÜBERIT®

Küberit Profile Systems GmbH & Co. KG
Römerweg 9 · 58513 Lüdenscheid · Germany

Tel.: +49 2351 9507 0
Fax: +49 2351 9507 49
Fax Export: +49 2351 9507 200

kueberit@kueberit.com
export@kueberit.com



Ihr Küberit-Fachhändler · Your Küberit dealer

PDF



kueberit.com/qr/prosp

© Küberit® 01-2025 • 19440298